

IMAGE



MODEL

3880H-DS

F-Version Hood

TOP VIEW

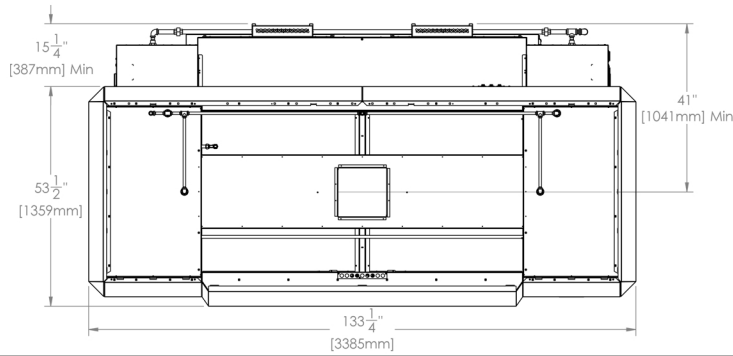

FRONT VIEWS

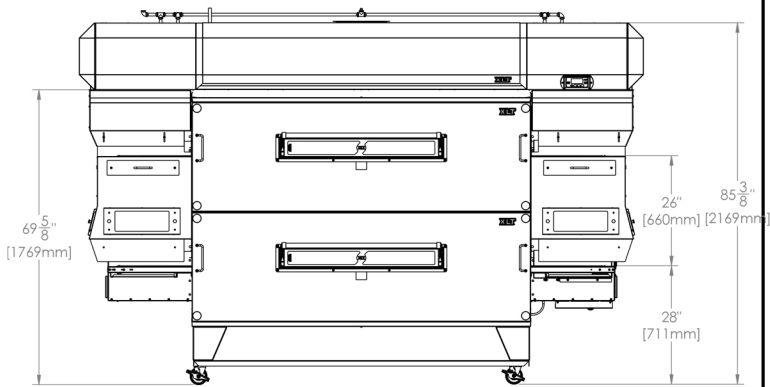

SIDE VIEWS

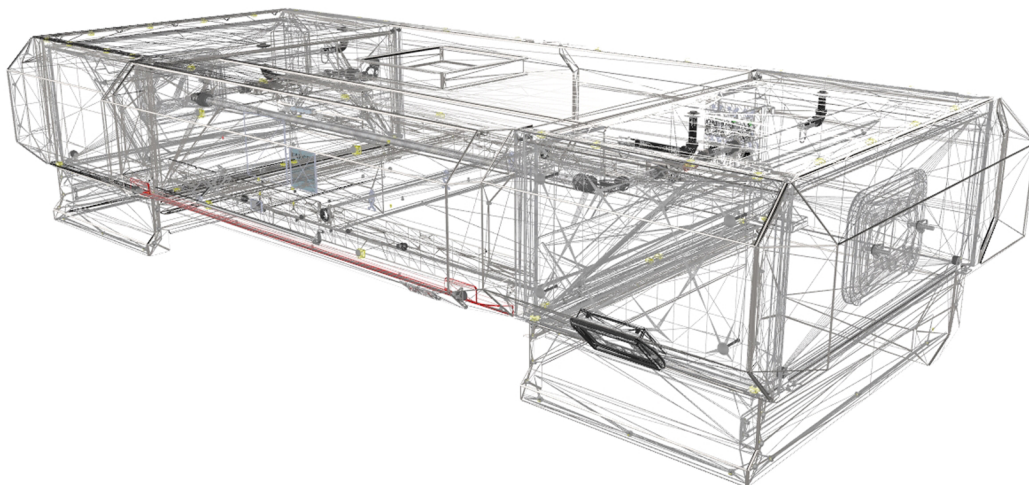
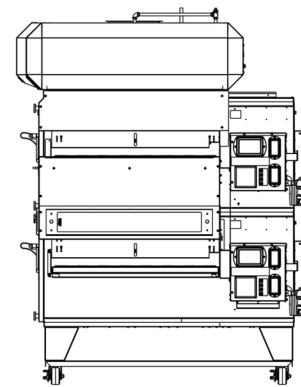

DATA SHEET

F-VERSION HOOD FOR XLT 3880-DS OVEN

ELECTRIC UTILITY SPECIFICATIONS

Inputs Into Electrical

	Standard	World
VAC	208/240 VAC	230 VAC
Amps	3 Amps	3 Amps
Hz	60 Hz	50 Hz
Phase	1 Phase	1 Phase

*Do not connect to 3 phase power. 1 phase only.

Output From Electrical

The XLT Hood System Provides:

Up to three (3) switching outputs for HVAC damper and/or dedicated unit.*

One (1) 230 VAC, 4.3 Amp, variable frequency, three (3) phase power output for the ventilation exhaust fan.
(Maximum output: 10 Amp)*

Relocation cord will physically connect into oven.

One (1) 24 VDC fire alarm signal.*

Up to three (3) receptacles for ovens.

*VFD only.

HOOD AND SHROUDS WEIGHT

	Hood Only		Hood & Shrouds			
			Double		Triple	
	lbs	kg	lbs	kg	lbs	kg
Hood and/or Shrouds Only	493	224	743	337	N/A	N/A

EXHAUST FLOW RATES

	Double Stack	Triple Stack
CFM (All Ovens On)	800	1140
M3/Min (All Ovens On)	22.65	32.28
Efficiency Comparison	17.18% More Efficient Than E-Version	22.08% More Efficient Than E-Version

*Figures represent TOTAL VOLUME measured at the duct (Minimum recommended). Refer to XLT Ovens I&O Manual for full complete information.

EXHAUST FAN AND CURB

Specs

Dimensions	inches	mm	inches	mm	inches	mm
	31	787	31	787	67	1702
Crated Weight (Stacked)	lbs	kg				
	185	84				

OVEN & HOOD WARRANTY

USA & Canada (Parts & Labor)	International (Parts & Labor)
10 Years Oven & Hood Combo Purchase*	7 Years Oven & Hood Combo Purchase
7 Years Standard	5 Years Standard

*Pre-piped fire suppression system must be purchased on each oven and hood.

