



MODEL

1832

H-version

SIZE

**18" WIDE CONVEYOR
32" LONG BAKE CHAMBER**

TYPE

GAS & ELECTRIC

TOP VIEW

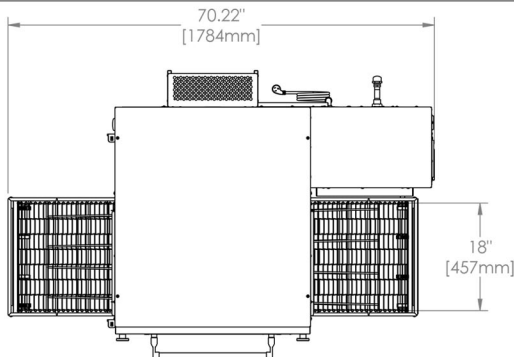

FRONT VIEWS

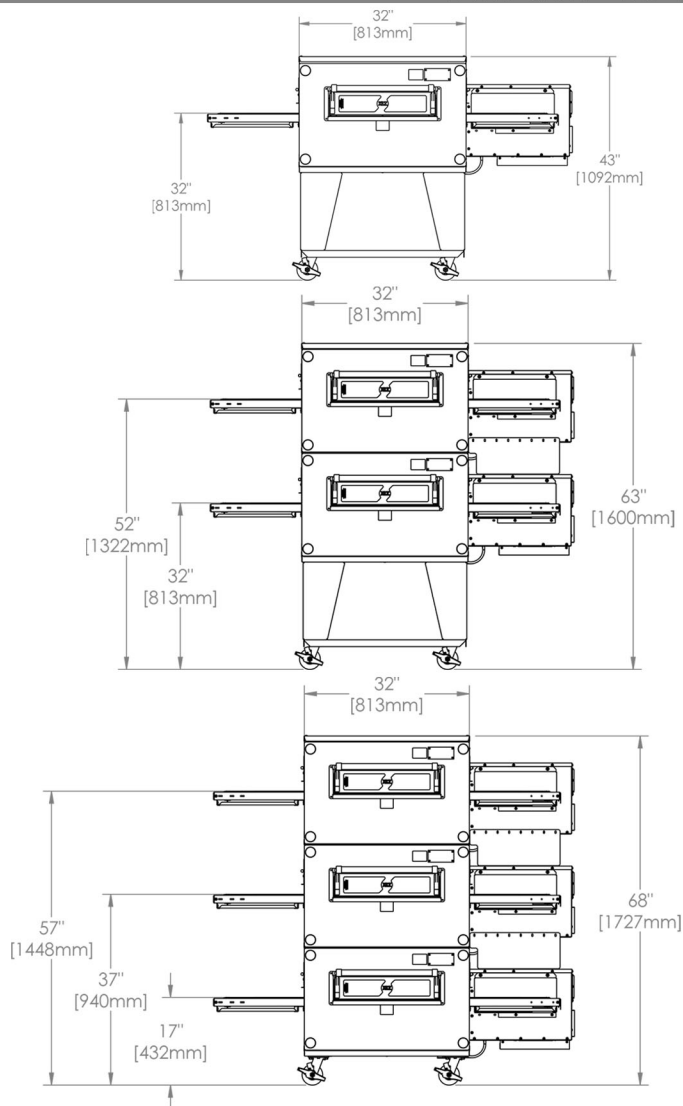

SIDE VIEWS

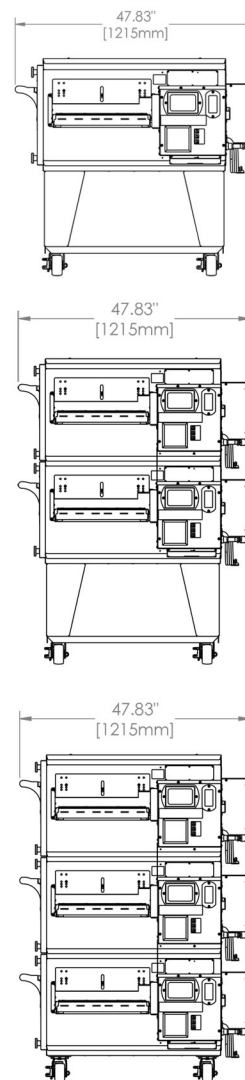

1832

MODEL

H-version



DATA SHEET

1832H GAS OVEN

Heating Value

Standard	World		
	Natural	Propane	Butane
56,000 BTU/Hr	16.41 Kw/Hr	16.41 Kw/Hr	18.50 Kw/Hr
	59.08 Mj/Hr	59.08 Mj/Hr	

Electrical Requirement

Standard	World
120 VAC, 4.8 Amps, 50/60 Hz	220/230/240 VAC Option, 3 Amps, 50/60 Hz

Inlet Pressure Range

	W/C	mbar	kPa	kPa (Korea)
Natural Gas	6-14	15-35	1.50 - 3.50	1.50 - 2.50
Propane Gas	11-14	27.5 - 35	2.75 - 3.50	2.30 - 3.30

Manifold Pressure Range

	W/C	mbar	kPa
Natural Gas	3.5	8.75	0.875
Propane Gas	10	25	2.50

Oven Weight	Single (1 crate)		Double (2 crates)		Triple (3 crates)	
	lbs	kg	lbs	kg	lbs	kg
Oven Only	569	258	1034	469	1343	609

1832H ELECTRIC OVEN

Electrical Requirement

	Standard	World
VAC	208/240 VAC	380/415 VAC
Amps	45/39 Amps	31/24 Amps
Hz	60 Hz	50 Hz
Wire Service	4 Wire Service - L1, L2, L3 +1 Ground (per oven)	5 Wire Service - L1, L2, L3 N+2 Grounds (per oven)
Phase	3 Phase	3 Phase
Kw	16 Kw	16/15 Kw

Oven Weight	Single (1 crate)		Double (2 crates)		Triple (3 crates)	
	lbs	kg	lbs	kg	lbs	kg
Oven Only	568	258	1030	467	1457	661

OVEN & HOOD WARRANTY

USA & Canada (Parts & Labor)	International (Parts & Labor)
10 Years Oven & Hood Combo Purchase*	7 Years Oven & Hood Combo Purchase
7 Years Standard	5 Years Standard

*Pre-piped ANSUL system must be purchased on each oven and hood



(316) 943-2751
SALES@XLTOVENS.COM
SERVICE@XLTOVENS.COM

WWW.XLTOVENS.COM
24/7/365 LIVE TECHNICAL SUPPORT

